

# PORTÃO

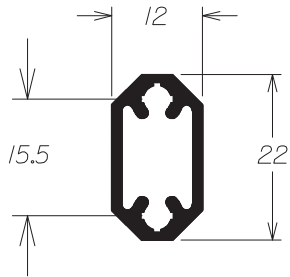

D-070  
0,252 Kg/m

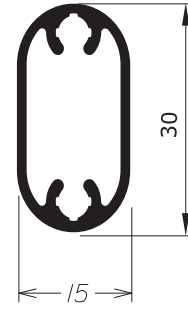

CG-087  
0,359 Kg/m

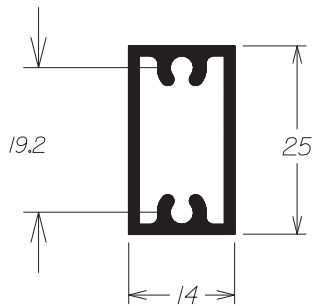

CG-021  
0,329 Kg/m

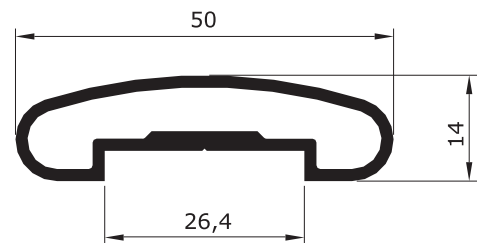

D - 095  
0,544 Kg/m



U - 598  
0,118 Kg/m

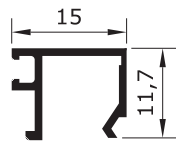

U - 482  
0,115 Kg/m

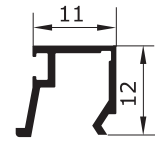

U - 522  
0,100 Kg/m

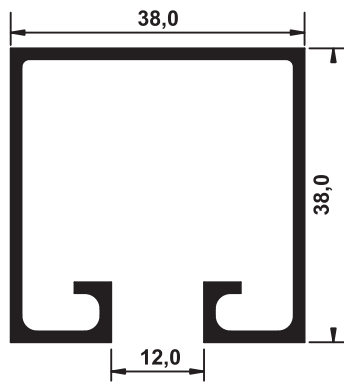

U - 990  
0,740 Kg/m

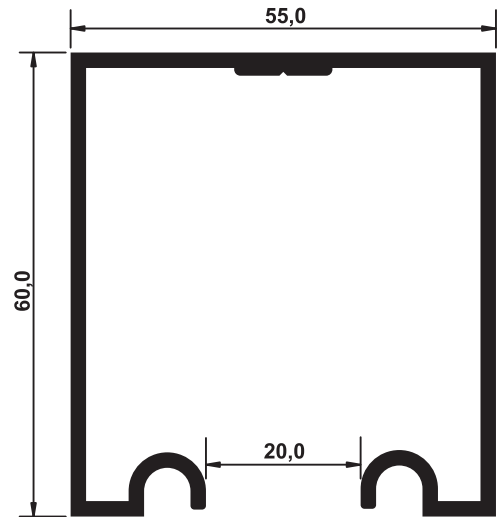

U - 1048  
1,453 Kg/m

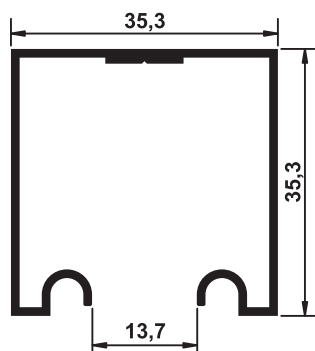

U - 1098  
0,565 Kg/m

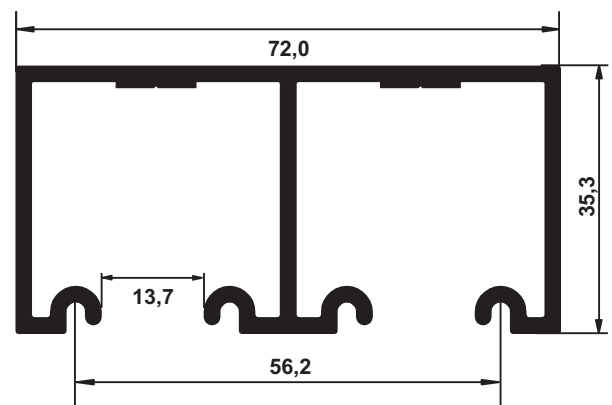

SP - 164  
1,294 Kg/m

# PORTÃO

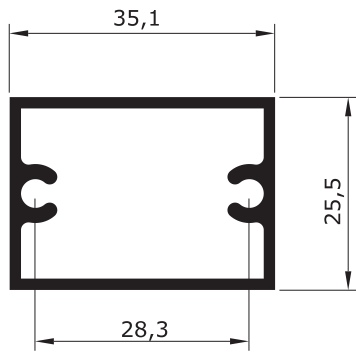

D - 055  
0,580 Kg/m

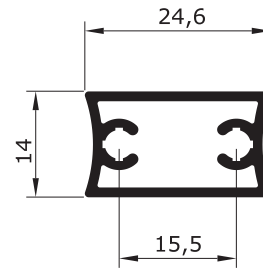

D - 056  
0,343 Kg/m

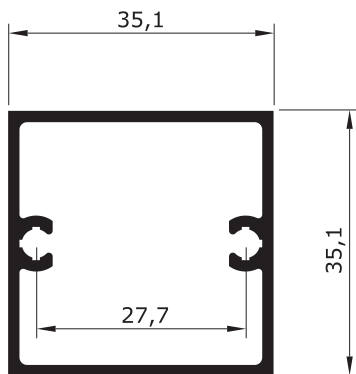

D - 081  
0,643 Kg/m

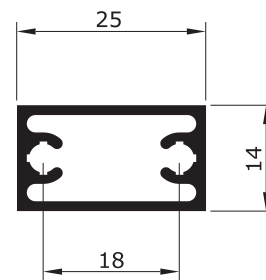

D - 082  
0,349 Kg/m

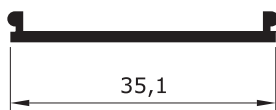

U - 495  
0,163 Kg/m

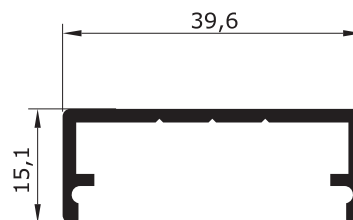

U - 496  
0,338 Kg/m

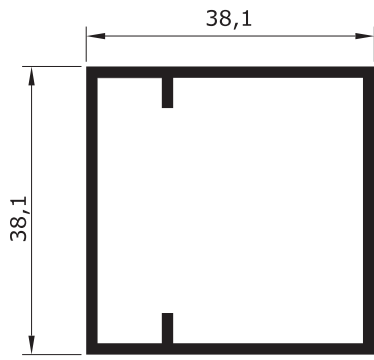

D - 102  
0,627 Kg/m

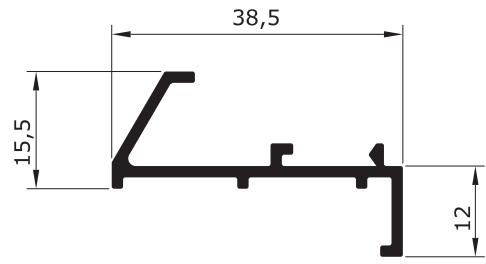

Z - 063  
0,325 Kg/m

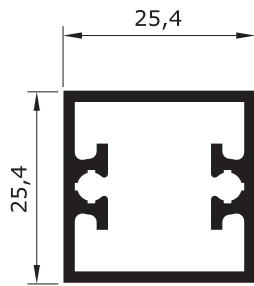

D - 080  
0,524 Kg/m

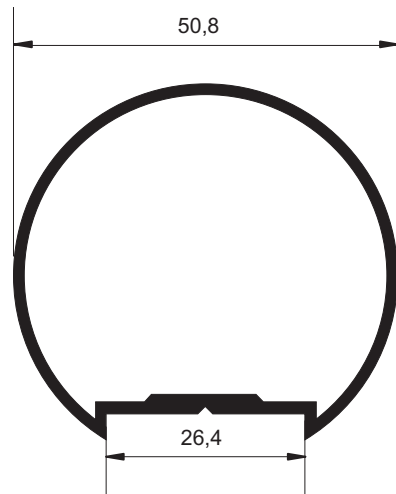

D - 094  
0,650 Kg/m

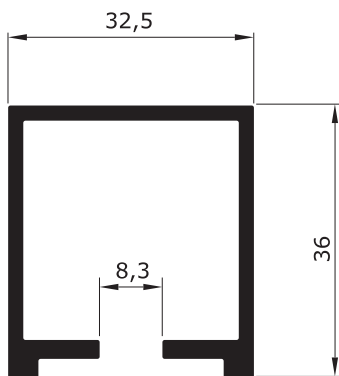

U - 164  
0,708 Kg/m

# BOX FRISADO

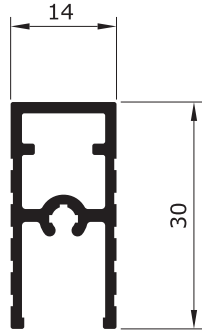

A - 087  
0,366 Kg/m

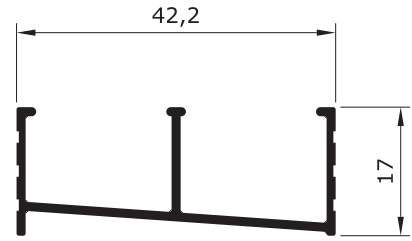

E - 256  
0,256 Kg/m

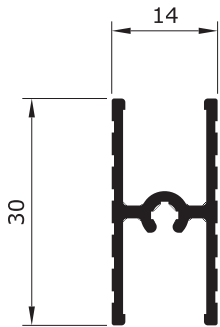

I - 154  
0,307 Kg/m

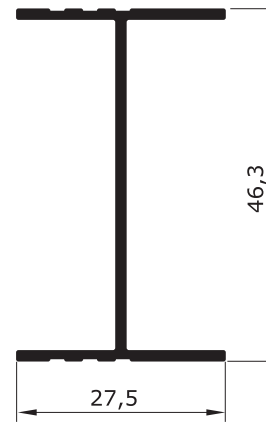

I - 155  
0,389 Kg/m

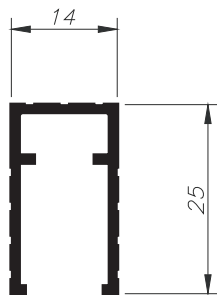

U - 652  
0,255 Kg/m

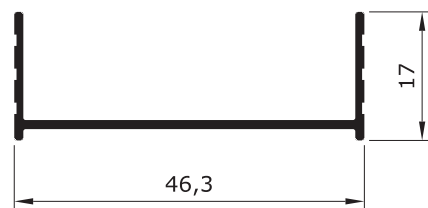

U - 653  
0,246 Kg/m

# BOX FRISADO

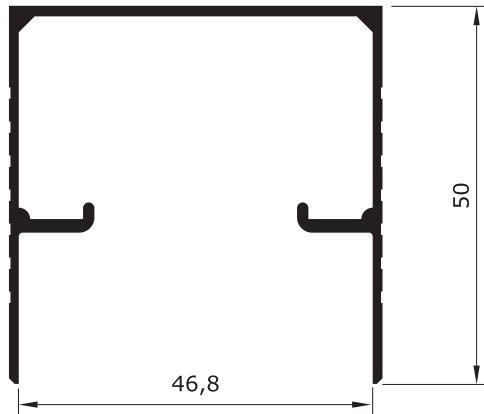

U - 655  
0,645 Kg/m

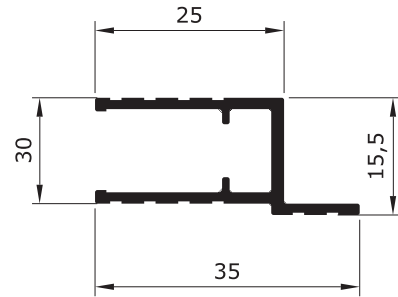

Y - 310  
0,302 Kg/m

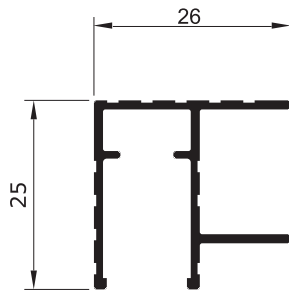

Y - 308  
0,280 Kg/m

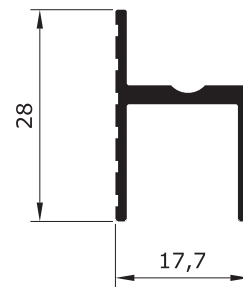

Y - 311  
0,264 Kg/m

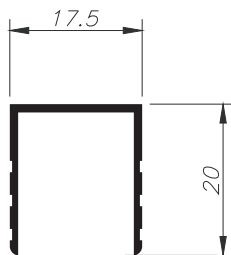

U - 654  
0,170 Kg/m

# BOX LISO

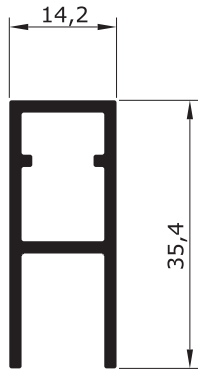

A - 022  
0,420 Kg/m

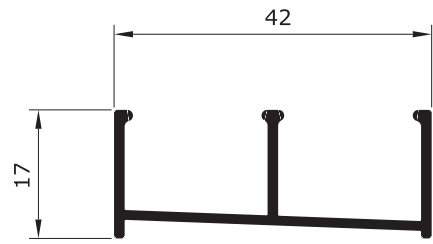

E - 117  
0,334 Kg/m

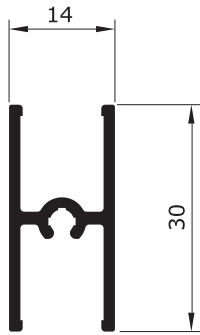

I - 083  
0,321 Kg/m

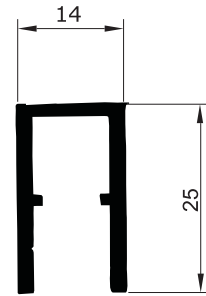

U - 396  
0,285 Kg/m

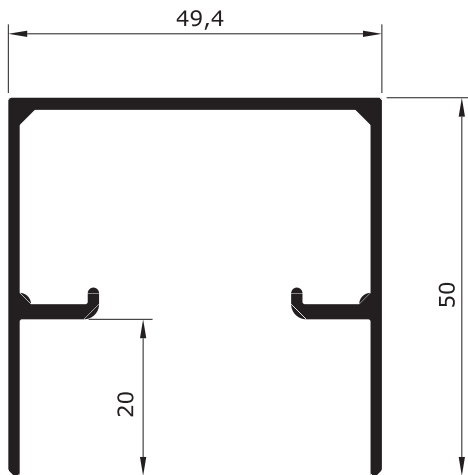

U - 397  
0,617 Kg/m

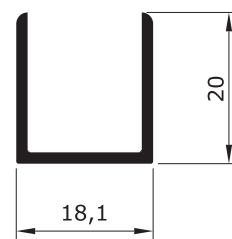

U - 398  
0,221 Kg/m

# BOX LISO

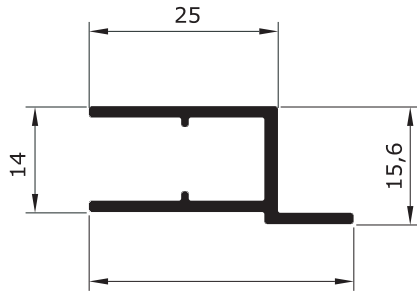

Y - 106  
0,217 Kg/m

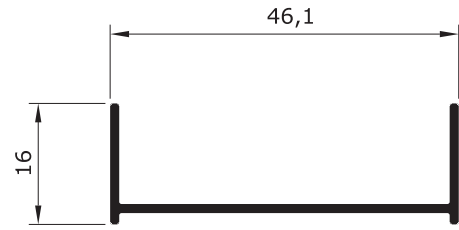

U - 399  
0,245 Kg/m

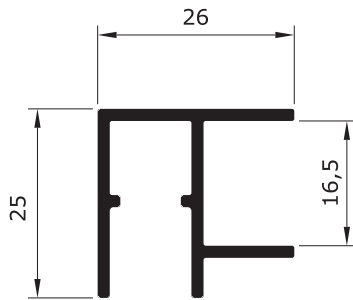

Y - 105  
0,380 Kg/m

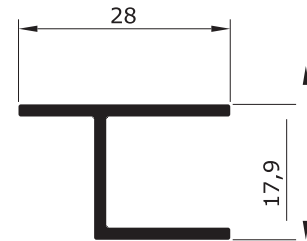

Y - 107  
0,263 Kg/m



# BOX BX

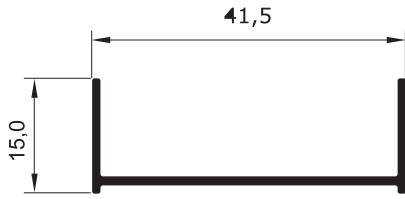

**BX - 245**  
0,190 Kg/m

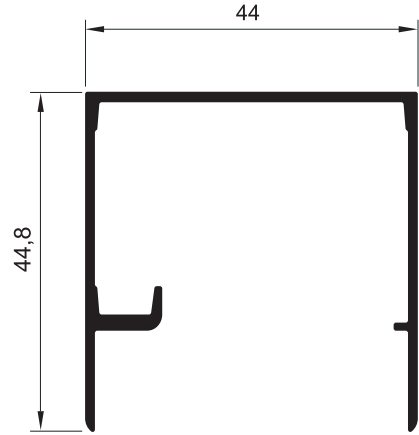

**BX - 248**  
0,505 Kg/m

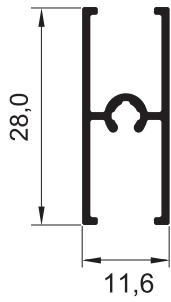

**BX - 246**  
0,216 Kg/m

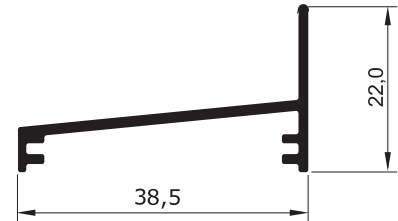

**BX - 249**  
0,257 Kg/m

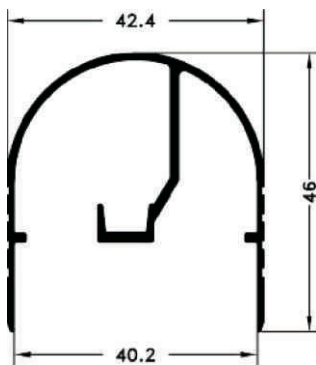

**BX - 248 A**  
0,504 Kg/m

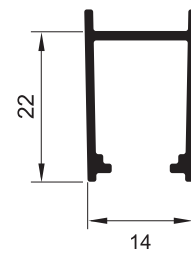

**BX - 250**  
0,168 Kg/m

# BOX BX

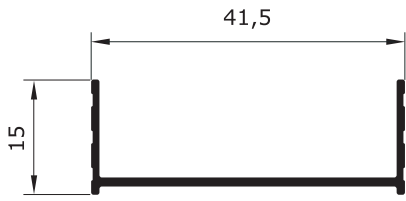

BX - 345  
0,181 Kg/m

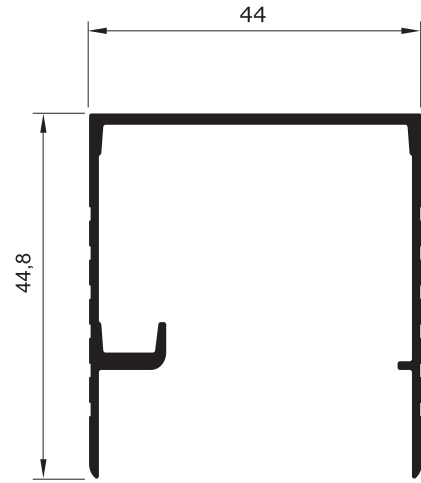

BX - 348  
0,495 Kg/m

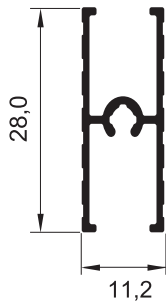

BX - 346  
0,208 Kg/m

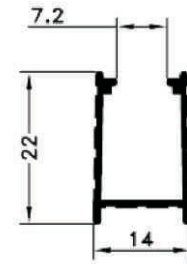

BX - 350  
0,154 Kg/m

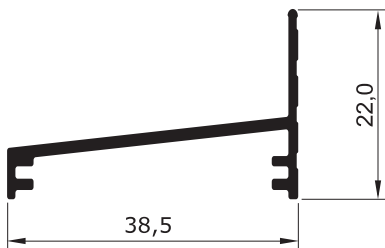

BX - 349  
0,251 Kg/m



BX - 550  
0,186 Kg/m



Brilhante

Bronze

Fosco

Preto

Pintura Eletrostática Branca

Jateado Bronze Claro

Linheiro Escuro

Jateado Fosco

[www.spaluminio.com.br](http://www.spaluminio.com.br)