

LINHA 30

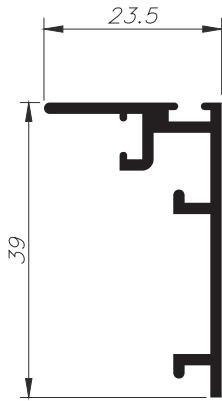

L - 518
0,366 Kg/m

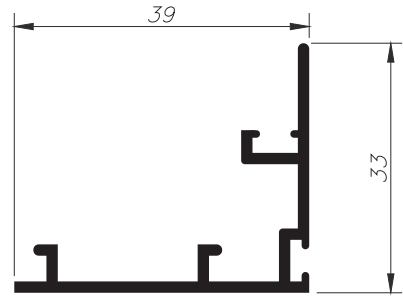

L - 517
0,402 Kg/m

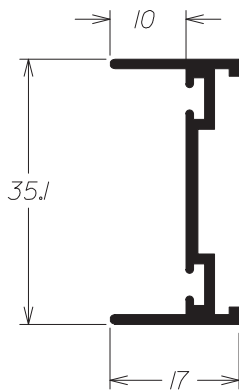

E - 150
0,295 Kg/m

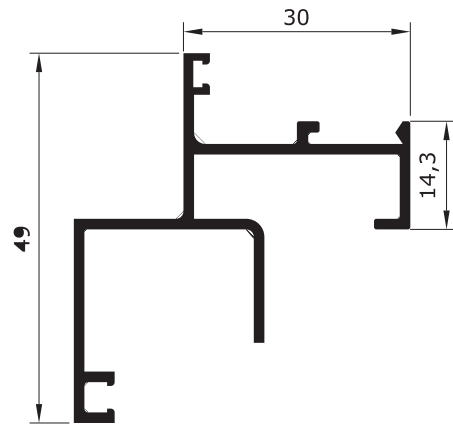

Y - 202
0,567 Kg/m

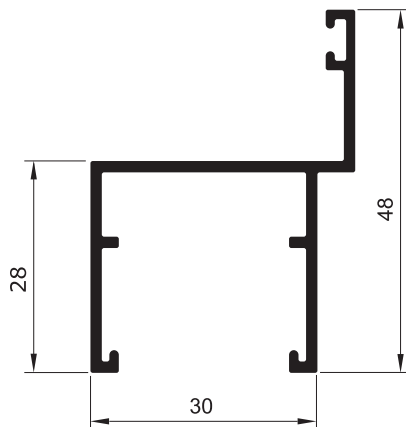

Y - 346
0,504 Kg/m

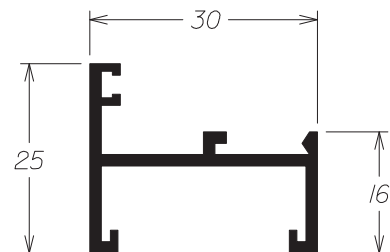

Y - 113
0,336 Kg/m

LINHA 30

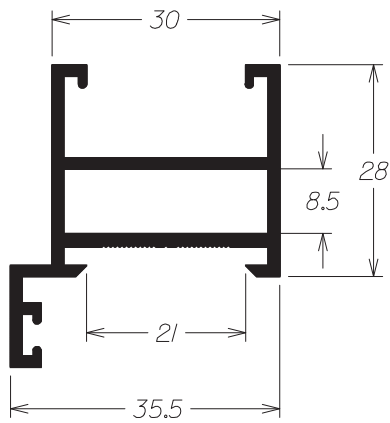

P - 273
0,615 Kg/m

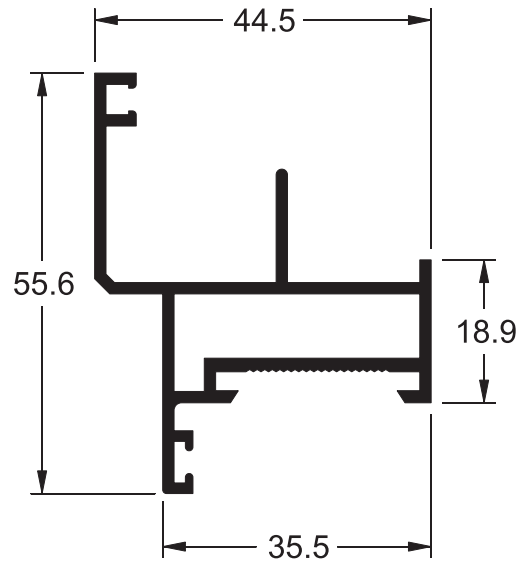

P - 272
0,775 Kg/m

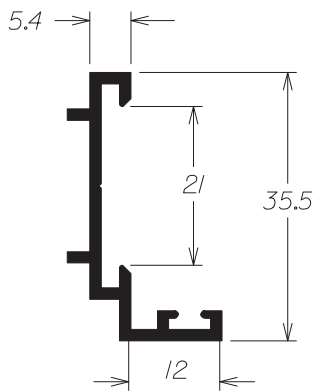

L - 519
0,297 Kg/m

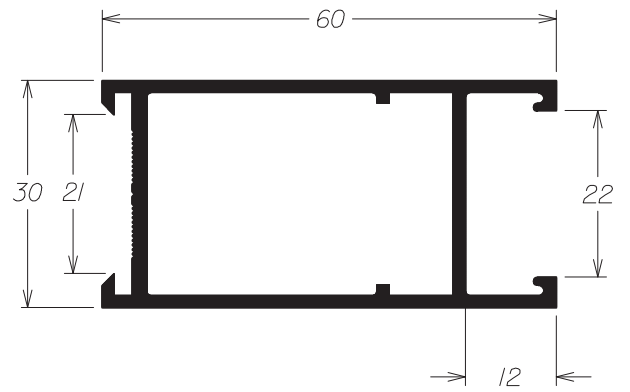

A - 144
0,829 Kg/m

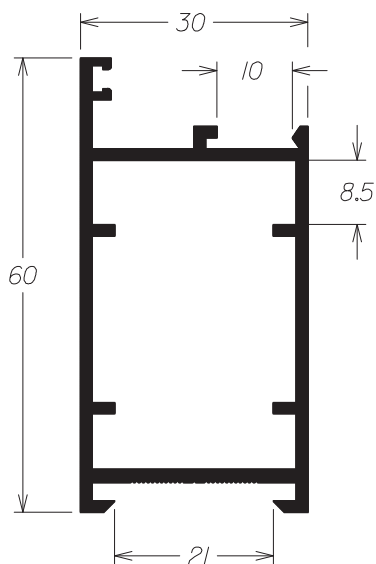

P - 270
0,780 Kg/m

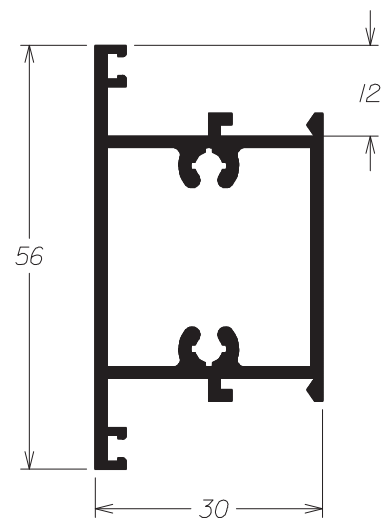

P - 078
0,793 Kg/m

LINHA 30

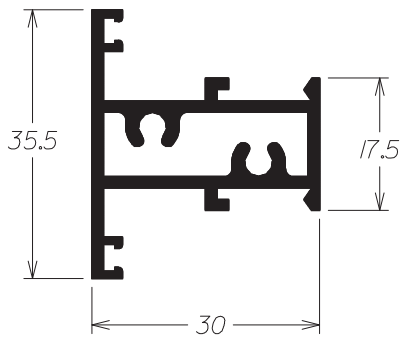

P - 075
0,590 Kg/m

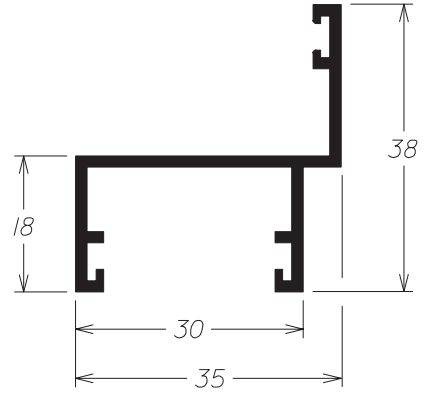

Y - 140
0,435 Kg/m

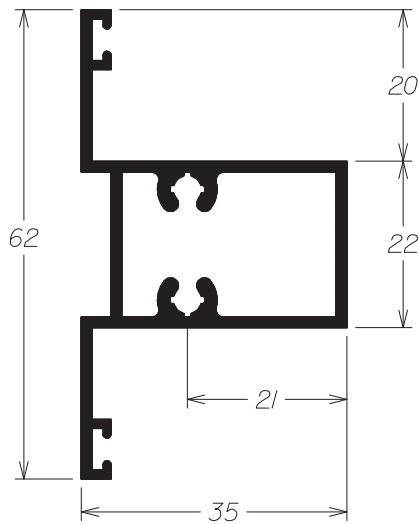

P - 419
0,726 Kg/m

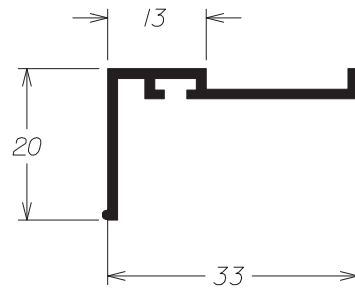

L - 387
0,210 Kg/m

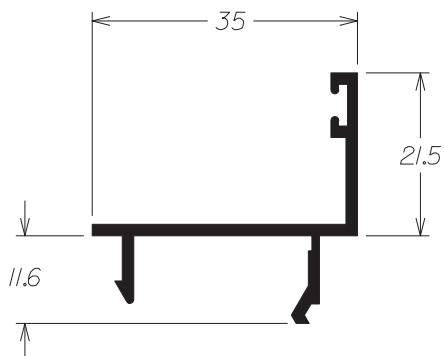

Y - 148
0,340 Kg/m

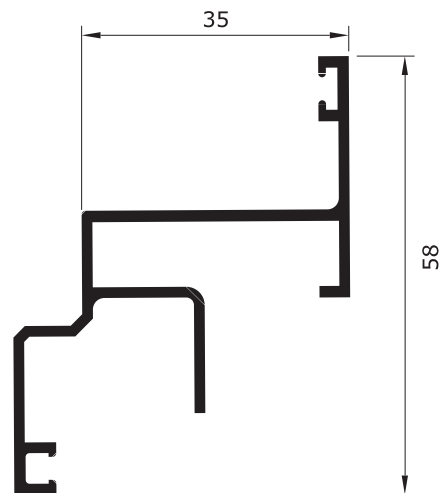

Y - 214
0,606 Kg/m

LINHA 30

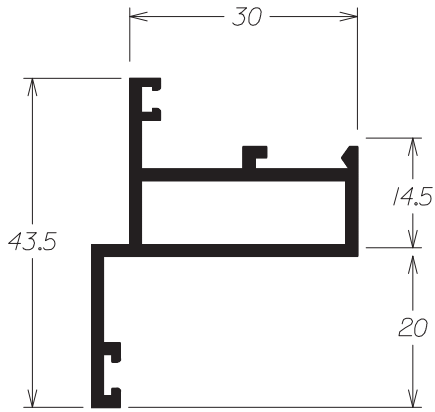

P - 120
0,533 Kg/m

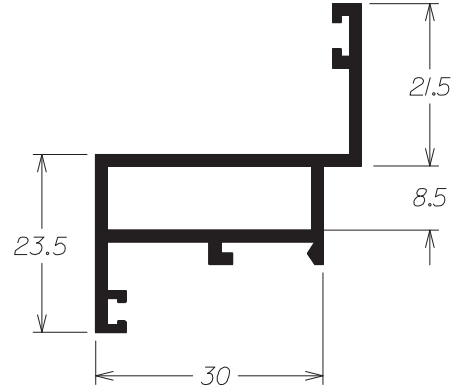

P - 121
0,533 Kg/m

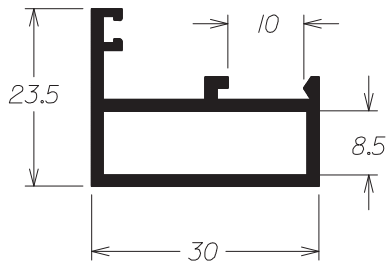

P - 064
0,408 Kg/m

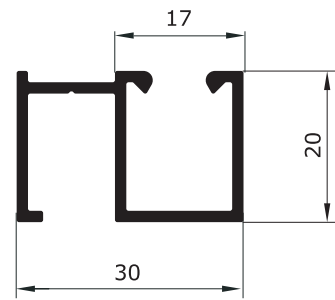

Z - 082
0,393 Kg/m

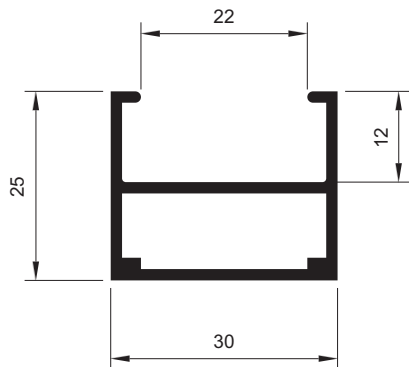

A - 209
0,463 Kg/m

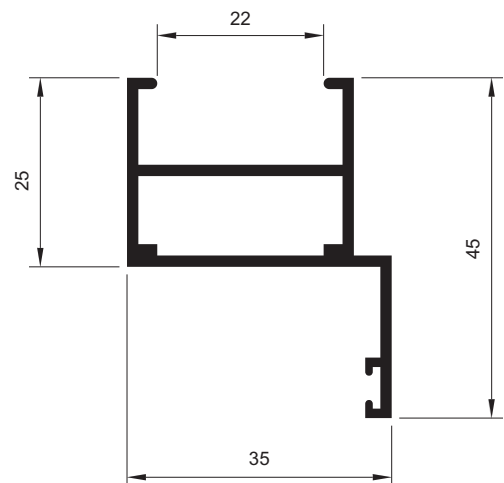

P - 575
0,583 Kg/m

LINHA 30

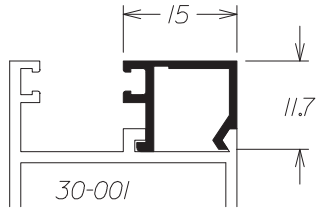

U - 482
0,115 Kg/m

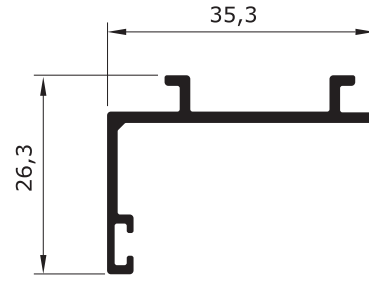

L-366
0,283 Kg/m

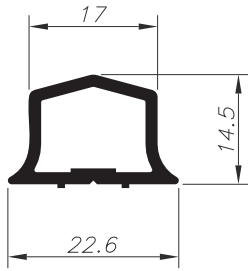

A - 213
0,254 Kg/m

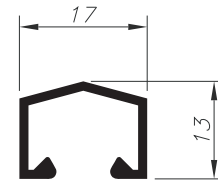

U-685
0,156 Kg/m

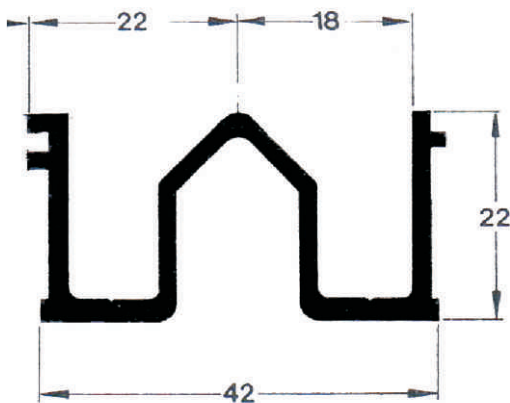

E - 487
0,600 Kg/m

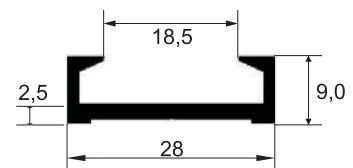

U - 690
0,260 Kg/m

LINHA 42

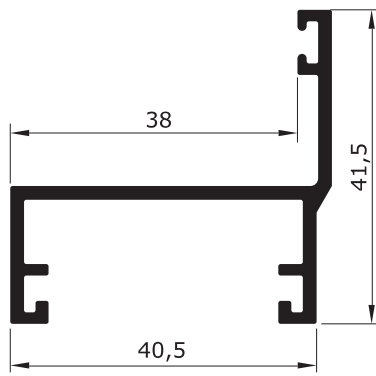

Y-181
0,570 Kg/m

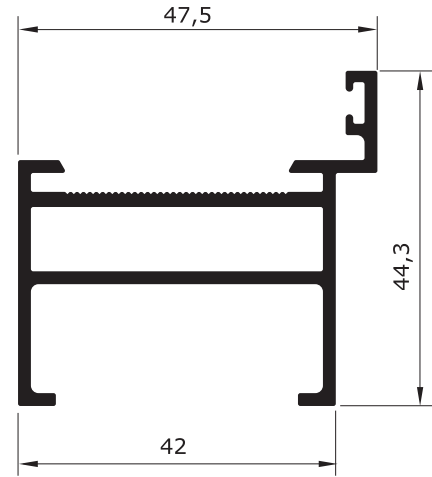

P - 280
0,855 Kg/m

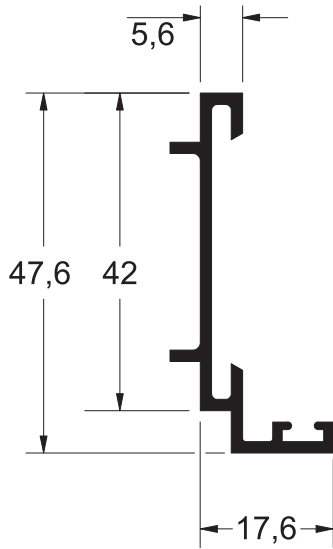

L - 521
0,368 Kg/m

PORTÃO

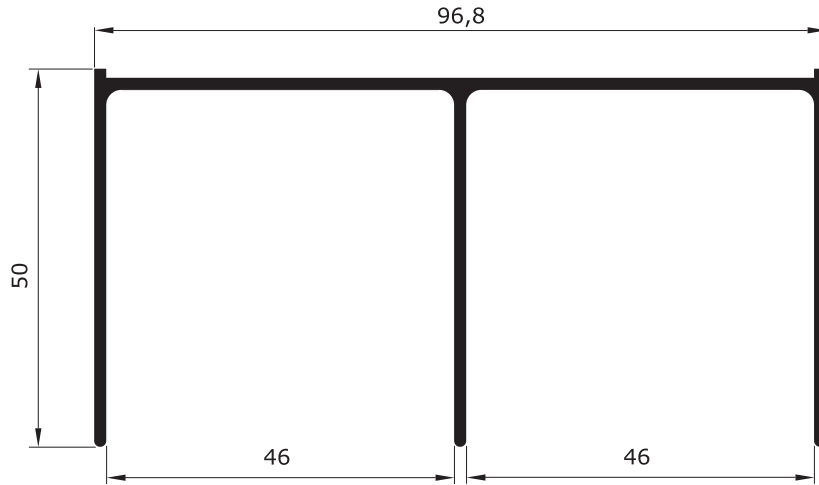

E - 363
1,043 Kg/m

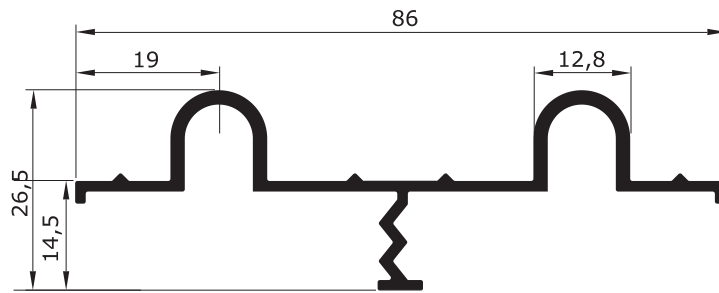

E - 365
0,656 Kg/m

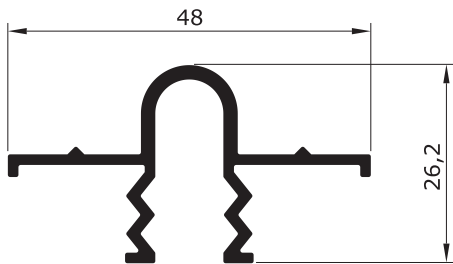

E - 364
0,458 Kg/m

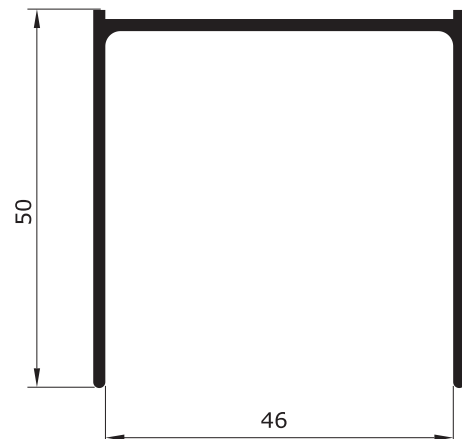

M - 027
0,636 Kg/m

PORTÃO

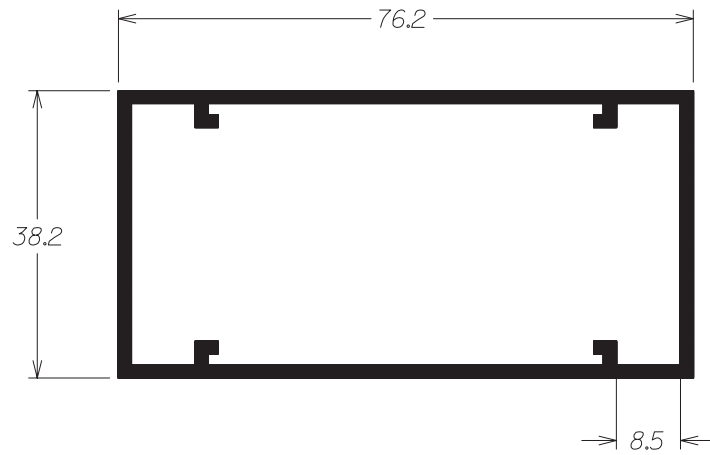

D - 069
0,945 Kg/m

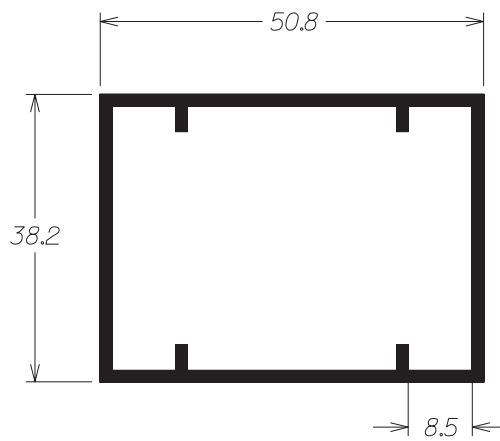

D - 078
0,755 Kg/m

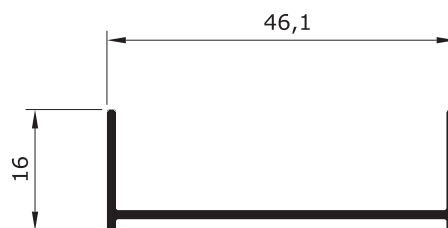

U - 399
0,245 Kg/m

PORTÃO

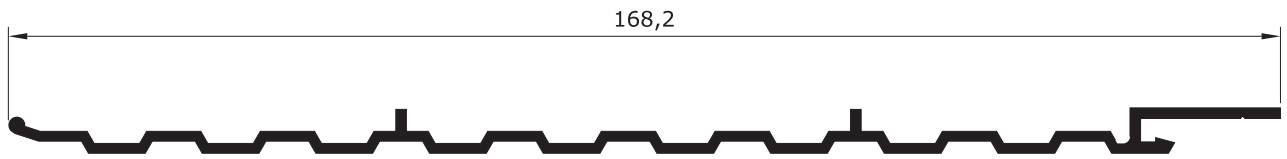

Y - 355
0,871 Kg/m

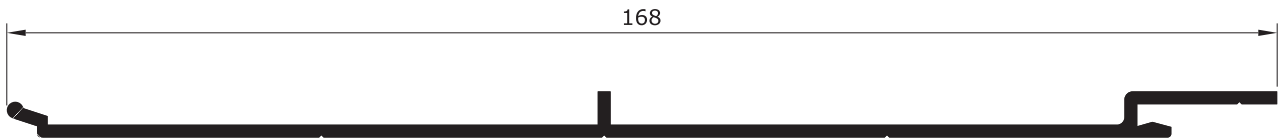

Y - 335
0,841 Kg/m



Y - 429
0,685 Kg/m

PORTÃO

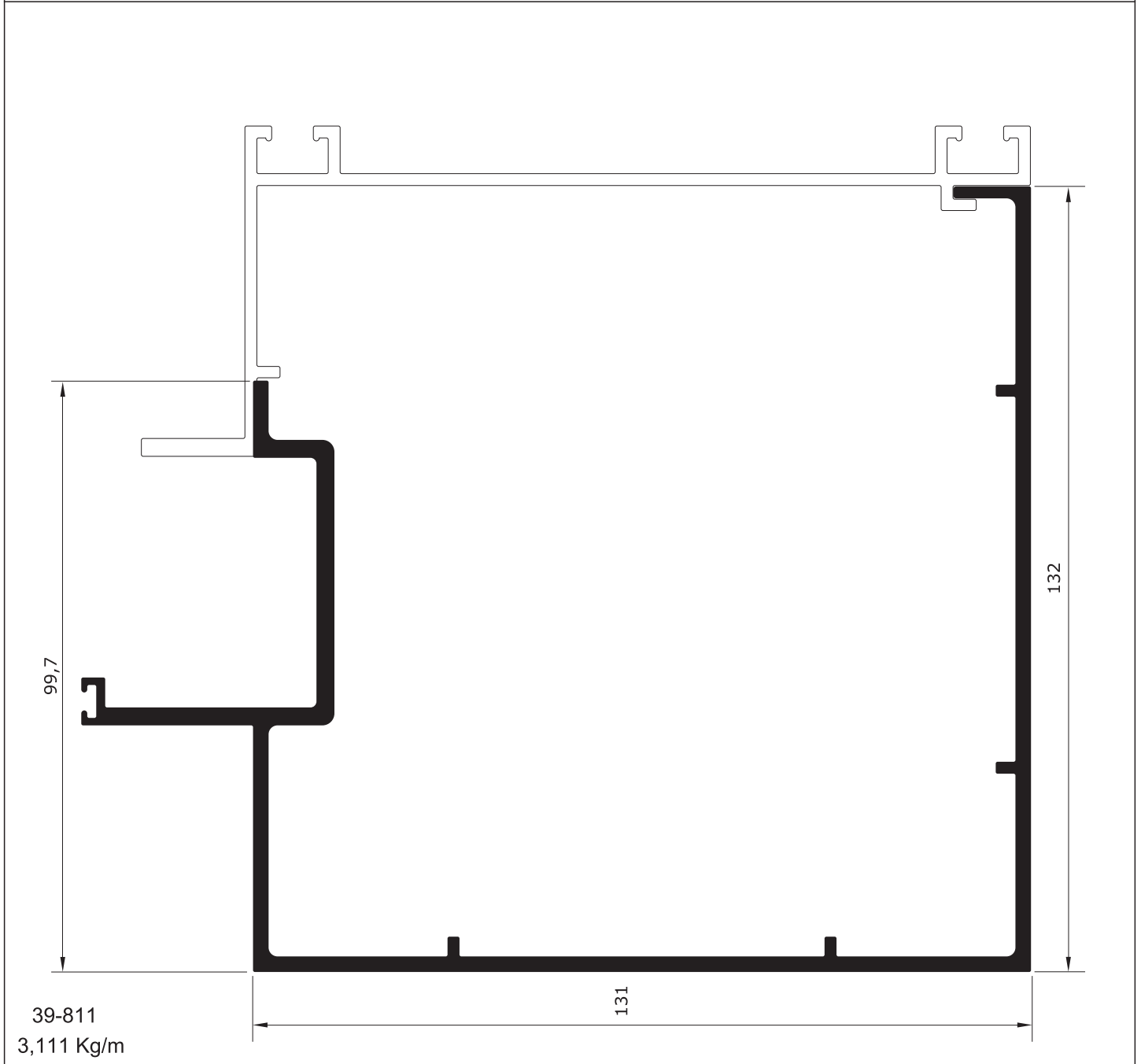
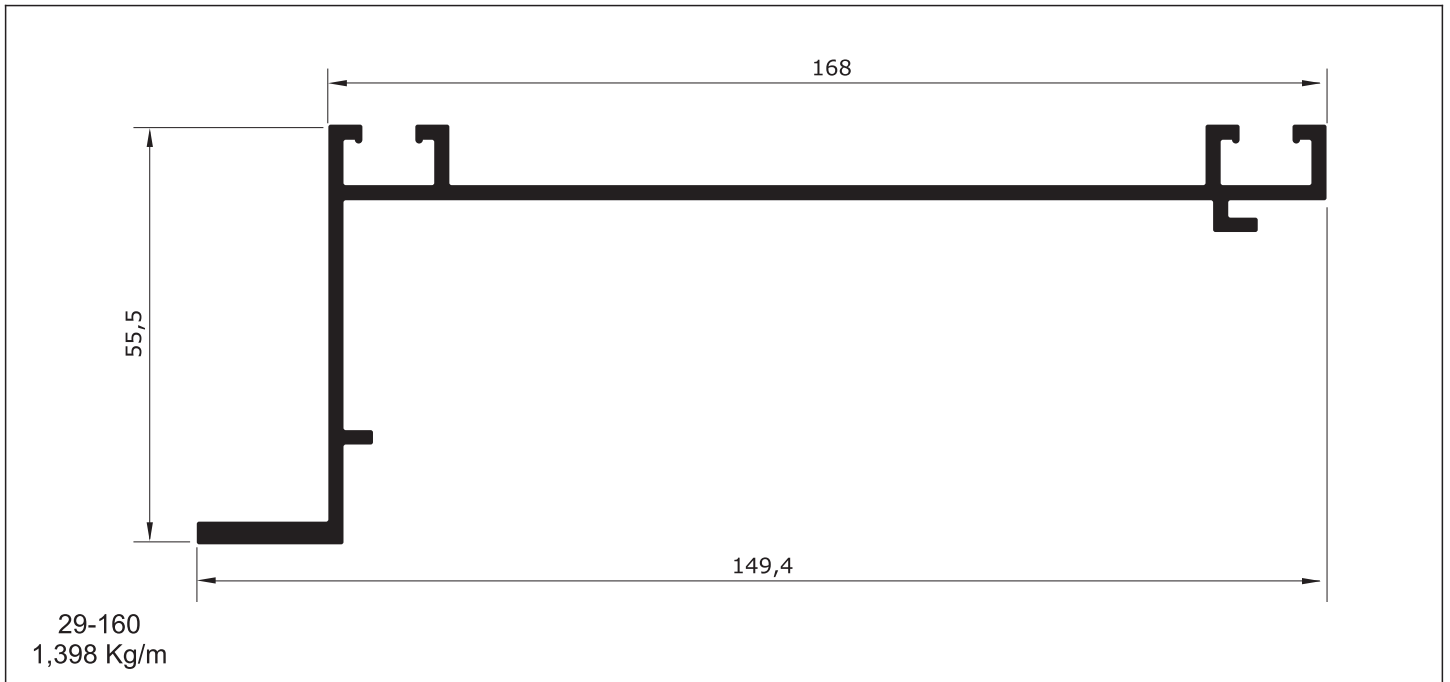

PORTÃO

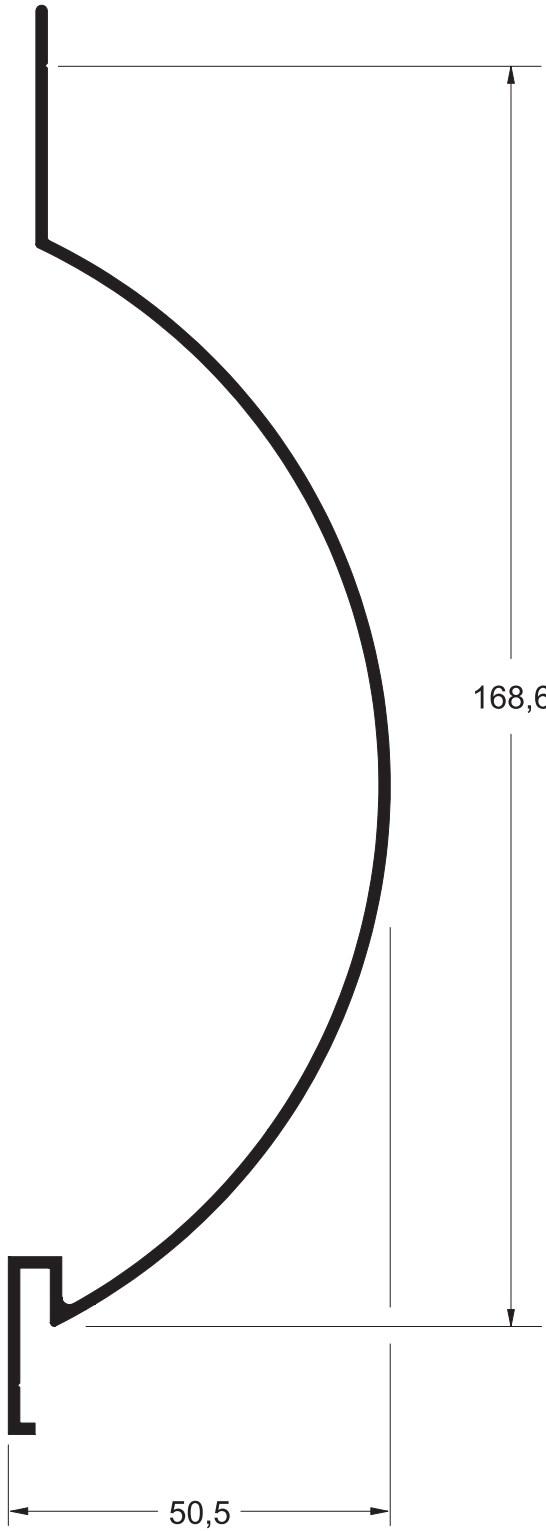

U - 1040
1,062 Kg/m

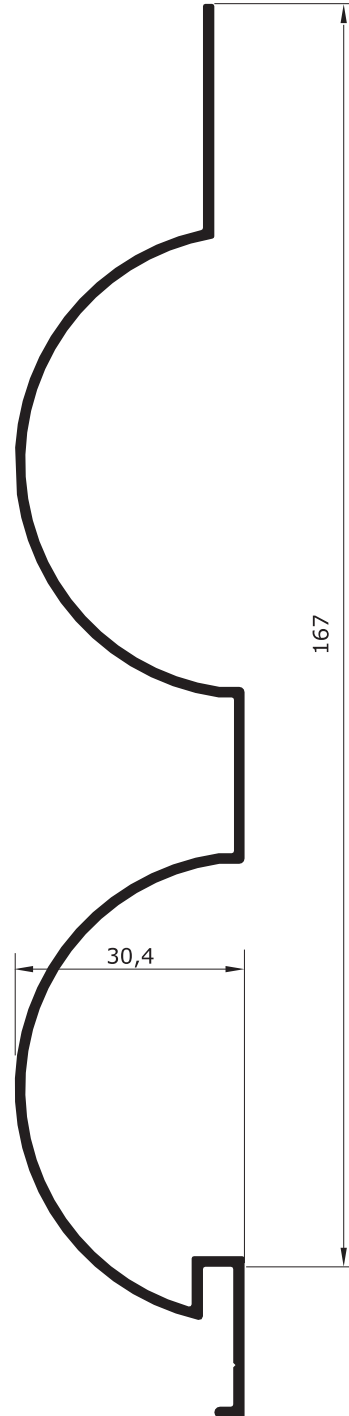

U - 1040A
1,018 Kg/m

PORTÃO

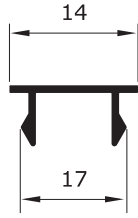

U - 491
0,093 Kg/m

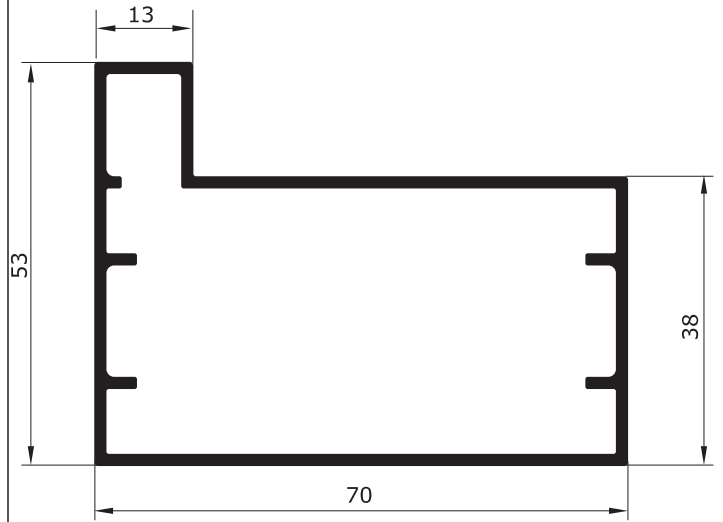

D - 141
1,111 Kg/m

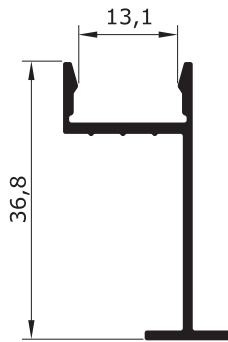

50-018
0,263 Kg/m

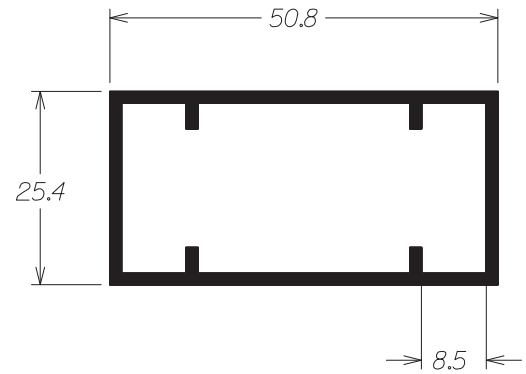

D - 079
0,650 Kg/m

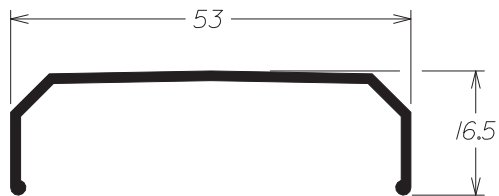

U - 498
0,262 Kg/m

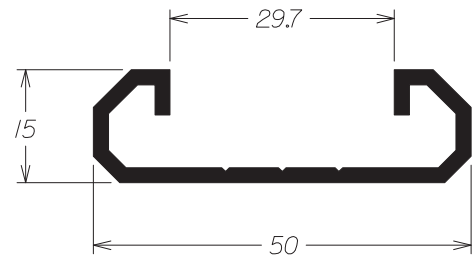

U - 497
0,464 Kg/m

PORTÃO

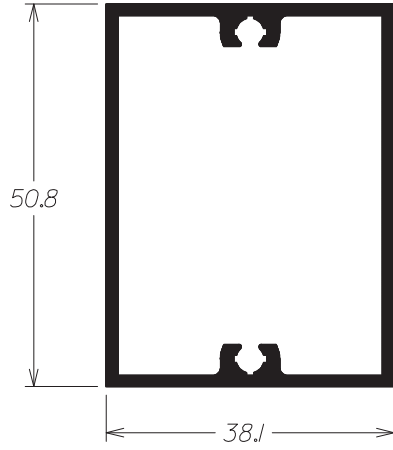

D-103
0,802 Kg/m

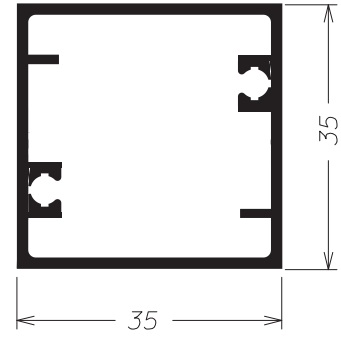

CG-058
0,632 Kg/m



CG-017
0,358 Kg/m

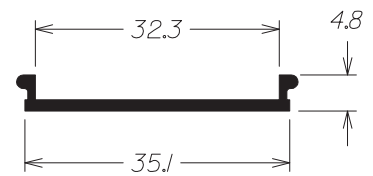

CG-019
0,173 Kg/m